

KATIE CHAIR range

HIGH BACK - RG630

LOW BACK - RG635

MAY 2020

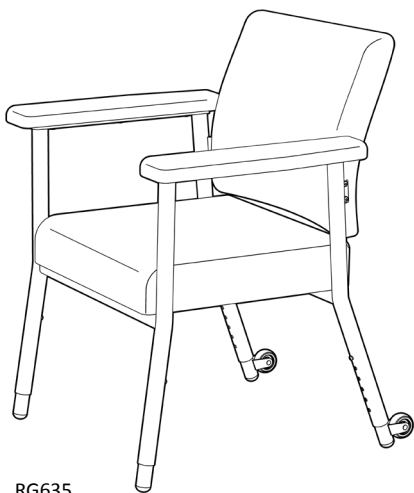

RG635

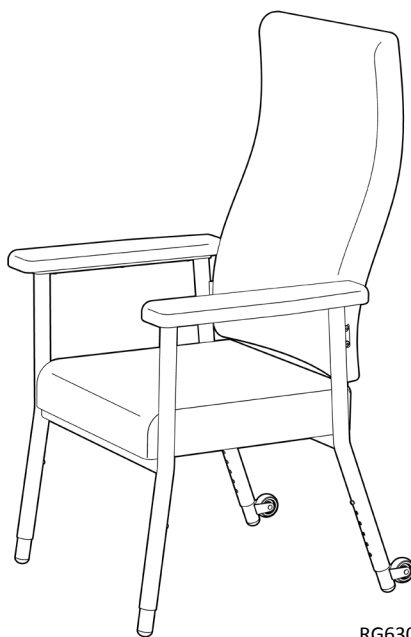

RG630

USER MANUAL

Please read and keep these instructions



REDGUM Brand owns the copyright to the KATIE CHAIR range user manual. Any information contained in this user manual shall not be photocopied, reproduced or translated into any other languages without the prior written consent of REDGUM Brand.

REDGUM Brand strives to provide the highest quality products possible that are subject to change without notice.

© Copyright **REDGUM Brand** 2020

REDGUM Brand is part of the FOR-DE Group.

CONTENTS

1. **INTRODUCTION** – INTENDED USE
2. **PRODUCT OVERVIEW** – FEATURES / SPECIFICATIONS
3. **ASSEMBLY** – UNPACK and INSPECT SUPPLIED PARTS
4. **ASSEMBLY** – INSTALL ADJUSTABLE LEGS
5. **ASSEMBLY** – INSTALL ARMRESTS
6. **ASSEMBLY** – INSTALL BACKREST
7. **USAGE GUIDELINES** – DO’S + DON’Ts
8. **SET UP** – CHAIR ADJUSTMENT
9. **PRODUCT CARE** – INSPECTIONS / SERVICING / CLEANING
10. **WARRANTY**
11. **NOTES**
12. **THE REDGUM BRAND PRODUCT RANGE**

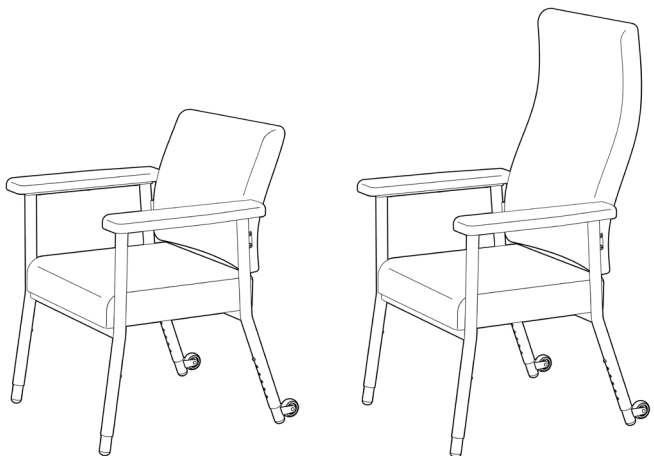

INTRODUCTION

Thank you for purchasing this quality **REDGUM Brand** product.

If you have any issues or questions about the **KATIE CHAIR** please contact your supplier or REDGUM Brand direct:

T: +61 8 9248 4180

F: +61 8 9248 9452

E: orders@for-de.com.au

A: 1 Business Way, Malaga Western Australia 6090

INTENDED USE

This product has limitations and should be used in accordance to these guidelines. Failure to follow these guidelines may result in damage to the product and injury to the user. It is the responsibility of the user to ensure the suitability of this product for its intended use. The user should consult their appropriate healthcare professional if unsure of the correct product usage for their unique circumstances.

Only use your **KATIE CHAIR** for the purpose for which it intended, which is as a **INDOOR** seating solution that can adjust to suit the users individual requirements.

IMPORTANT NOTE

This equipment **MUST** be assembled by a competent person.

Maximum User Weight: 200kg

Exceeding the weight limit could cause damage to the product and could put the user at risk.

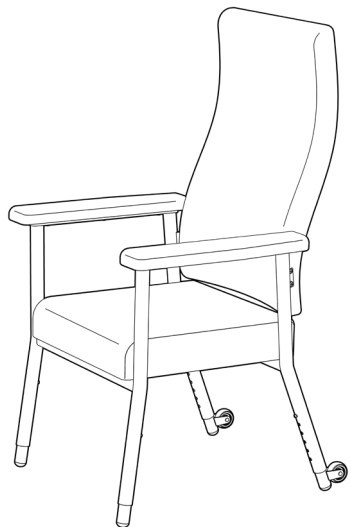

PRODUCT OVERVIEW

FEATURES

Adjustable Seat Height
Adjustable Seat Depth
Contoured Padded Backrest
Comfortable Padded Seat
Large Padded Armrests
Chair Mobility Wheels to rear legs as standard
Backrest can be folded down for transit or storage
Strong lightweight construction
Epoxy Powder Coated framework
Vinyl covered upholstery

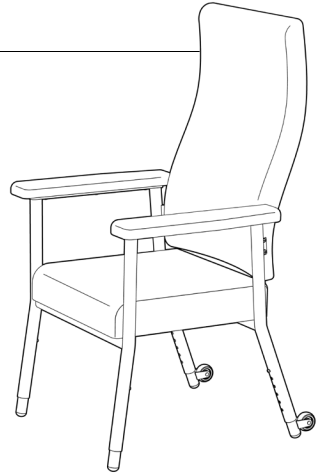

Please contact REDGUM Brand for information on KATIE CHAIR options

SPECIFICATIONS

(All dimensions shown are nominal)

Overall Width: **665mm** (at lowest setting)
Overall Depth: **650mm** (at lowest setting)
Overall Height: **1140mm** (at lowest setting)
Seat Width: **480mm** (between armrests)
Seat Depth: **435 – 475mm** (front of seat to middle of backrest)
Seat Height: **450 - 575mm**: 5 settings (floor to top of seat)
Armrest Height: **220mm** (top of seat to top of armrest)
Backrest Width: **480mm** (at widest point)
Backrest Height: **425mm** (low back) - **700mm** (high back) (top of seat to top of backrest)
Backrest Angle: **98°**
Mobility Wheel Diameter: **Ø50mm**
Product Weight: **11kg** (low back) - **13kg** (high back)

Maximum User Weight: **200kg**

Please contact REDGUM Brand if you would like any further information on your **KATIE CHAIR**.

ASSEMBLY - UNPACK and INSPECT SUPPLIED PARTS

Ensure you have been supplied with the following parts:

PARTS:

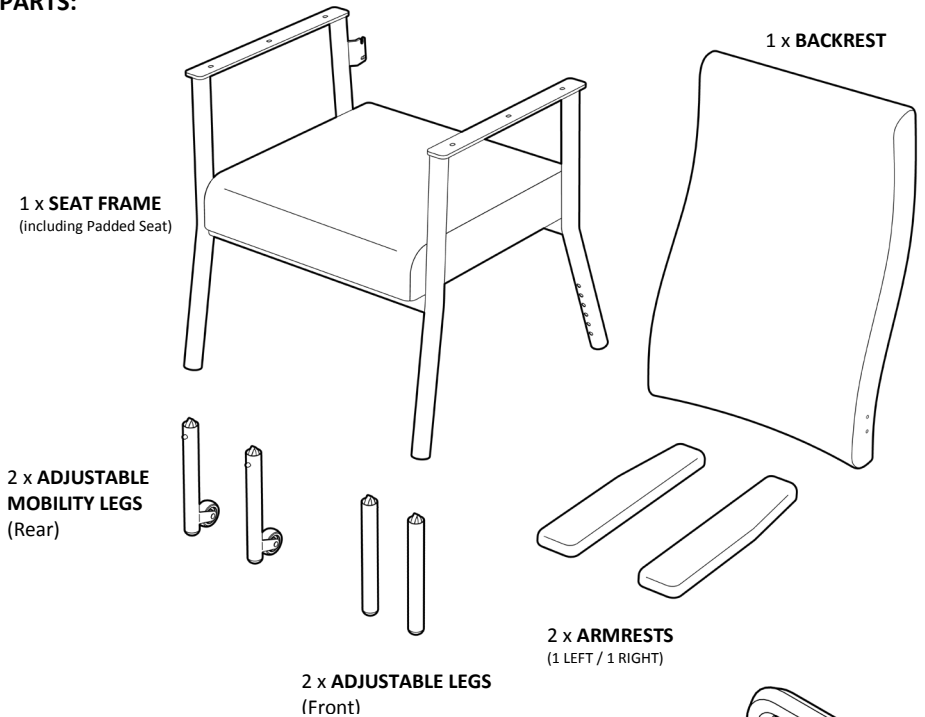

FASTENERS (not shown to scale)

10 x BOLTS

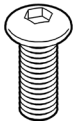

10 x BOLT HEAD COVER CAPS

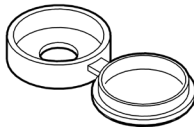

1 x ALLEN KEY

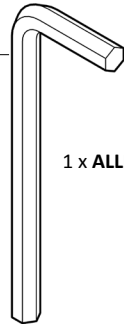

IMPORTANT NOTE

Check the product for any visible damage. If you see any damage or suspect a fault, **DO NOT USE YOUR PRODUCT** and contact your supplier for support.

ASSEMBLY - INSTALL ADJUSTABLE LEGS

Lay Seat Frame on its side as shown.

Before you install the Legs, ensure the Mobility Adjustable Legs (Leg with wheel) are positioned at the rear of the seat.

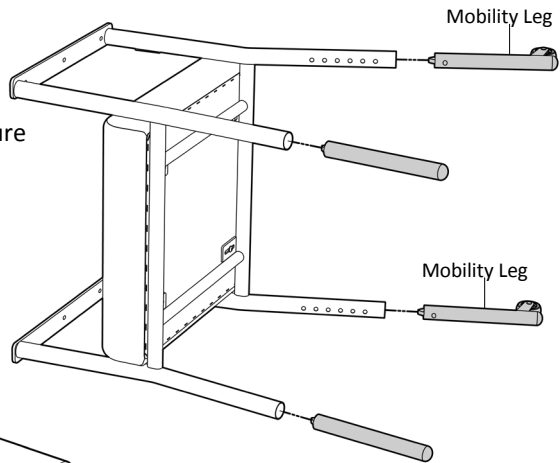

Insert the Adjustable Legs into the legs on Seat Frame.

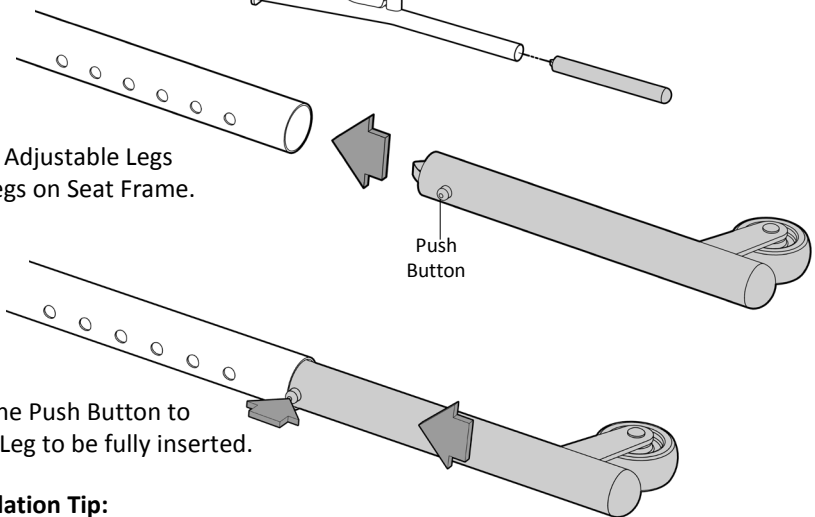

Depress the Push Button to allow the Leg to be fully inserted.

Leg Installation Tip:

Slightly rotate leg to offset push button and stop it from locating into each hole as it is being inserted.

IMPORTANT NOTE:

Ensure ALL LEGS are set to the SAME SETTING and the Press Buttons on each leg has **FULLY LOCATED** into the selected hole. The head of the press button **MUST PROTRUDE OUT** of the seat frame leg to ensure proper location.

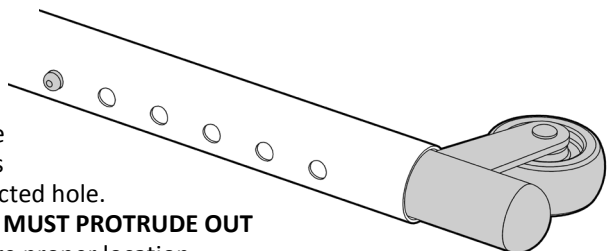

ASSEMBLY - INSTALL ARMRESTS

Stand the seat frame up onto its legs.

Position the armrests onto the seat frame as shown. Ensure that the taper on the armrests is on the outside of the chair.

Line up the holes on the underside of the armrests with the holes on the seat frame.

Fix the armrests in place following the steps below:

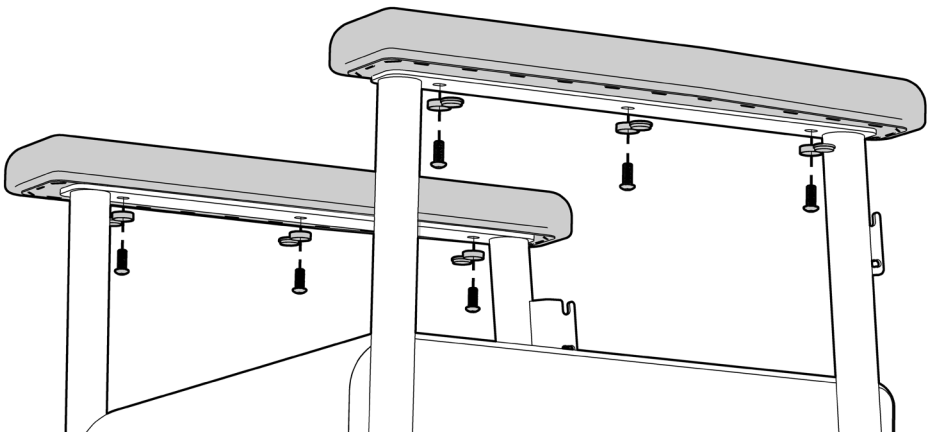
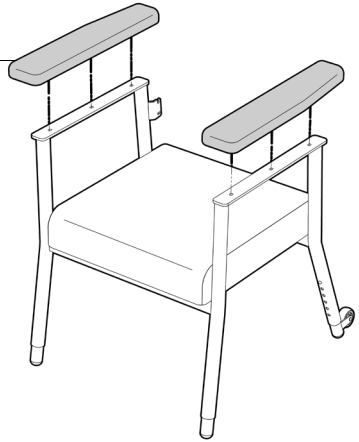

1. Locate bolts into holes on both arms.

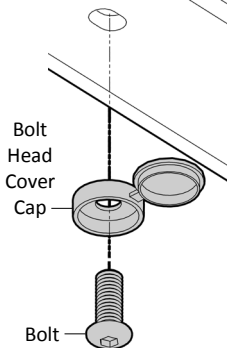

Allen Key

2. Tighten ALL SIX BOLTS using Allen key.

3. Close bolt head cover.

5.

ASSEMBLY - INSTALL BACKREST

Follow the following instructions to locate the backrest onto the seat frame:

IMPORTANT NOTE

Please take care locating the upholstered backrest onto the seat frame. Backrest covering may get damaged if dragged against seat frame.

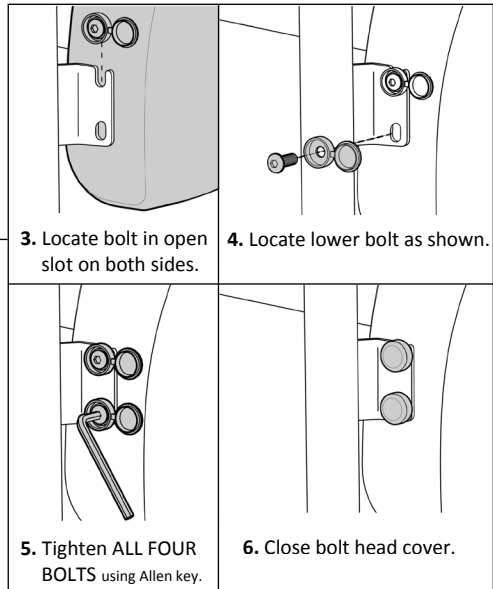
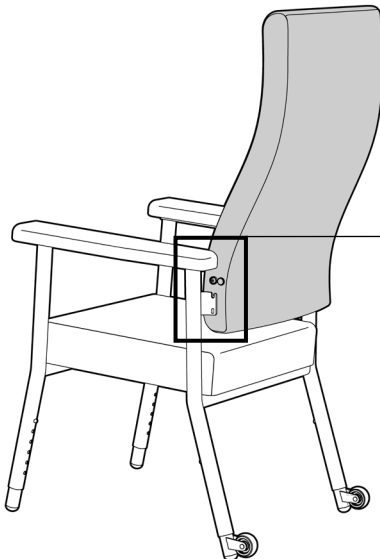
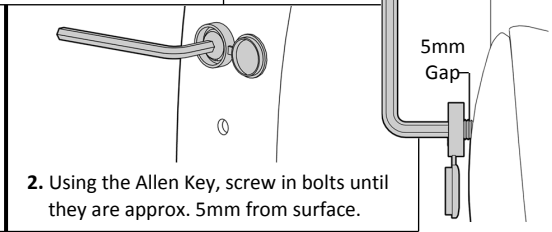
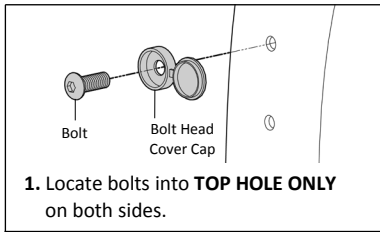
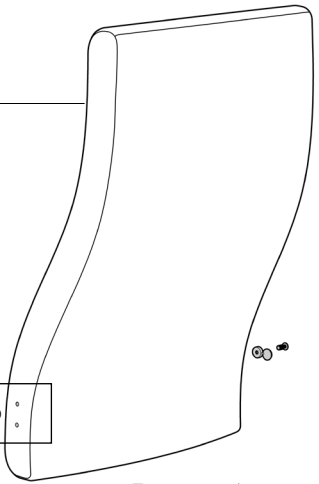
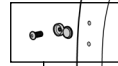

USAGE GUIDELINES

Please follow these guidelines to get the optimal benefit from the **Katie Chair**.

Failure to follow these guidelines may result in damage to the chair and put the user at risk.

200kg Maximum User Weight

Ensure ALL FOUR LEGS remain on ground at all times when chair is occupied:

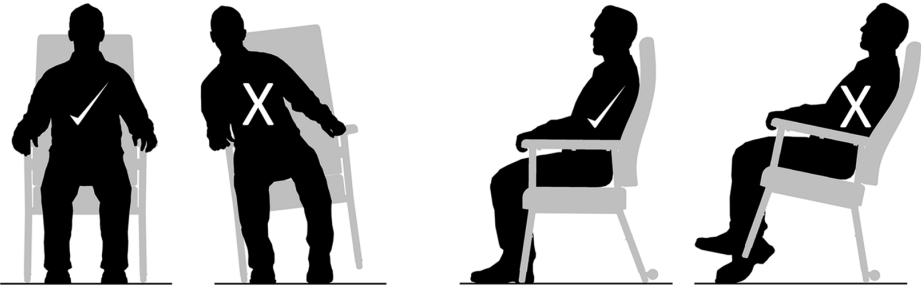
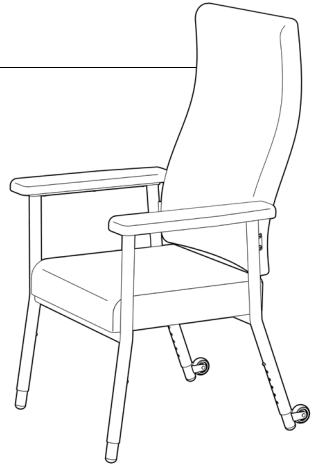

Do not lean too far to the side or backward causing legs to leave the ground

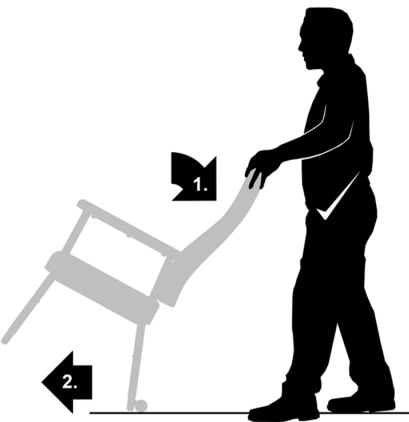

To move the chair, rotate back until the mobility wheels engage with the ground.

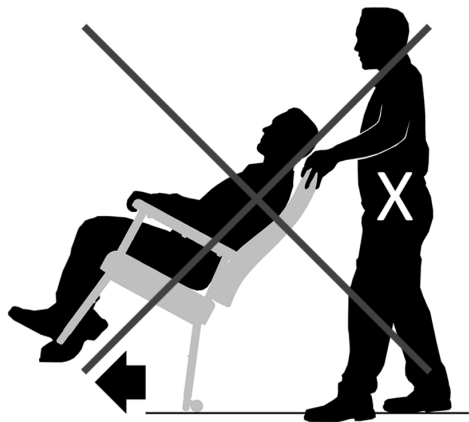

IMPORTANT NOTE:
Never move chair when occupied !

SET UP - CHAIR ADJUSTMENT

SEAT HEIGHT and ANGLE

Adjust the legs to the required height setting:
(Refer to page 4 for information on leg installation)

- Lay chair on its side to access legs
- Depress push button on leg
- Slightly rotate leg and adjust leg position
- Rotate leg to engage push button in required hole
- Ensure head of push button protrudes outside leg tube
- Repeat process for all four legs
- Front or rear legs can be set to achieve seat angle (if required)
- Stand chair on its legs – check height (repeat process if required)

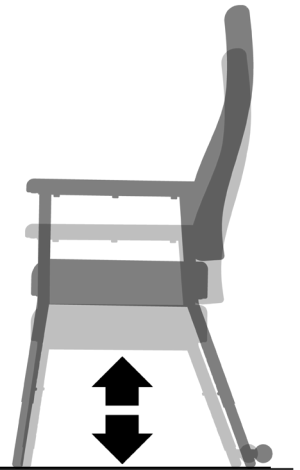

SEAT DEPTH

Adjust the seat to the required depth setting:

- Lay chair on its side to access underside of seat
- Loosen off **ALL** four bolts using Allen key provided
- Move seat to required position
- Re-tighten all four bolts
- Stand chair on its legs – check seat depth (repeat process if required)

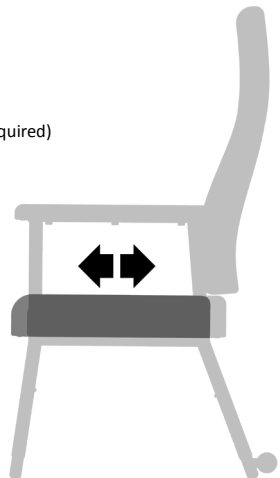
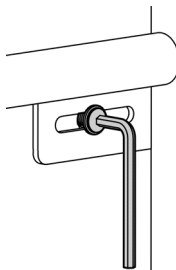
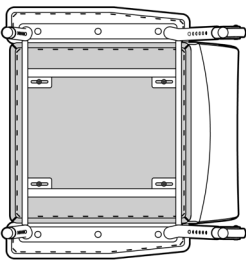

IMPORTANT NOTE

The user should consult their appropriate healthcare professional if unsure of the correct product setting and usage for their unique circumstances.

PRODUCT CARE - INSPECTIONS / SERVICING / CLEANING

INSPECTIONS

We suggest that you check your **KATIE CHAIR** visually **periodically** for signs of damage or wear prior to use.

Please check all aspects of the chair. However, pay particular attention to the following areas:

Metalwork – Ensure the frame is not damaged or distorted – no visible cracks.

Legs - Ensure all four legs are not damaged or distorted.

Fasteners – Check all bolts are done up tight / leg press buttons are engaged

Covering – Ensure all coverings are not ripped or torn.

Overall check that no components are loose or worn.



Withdraw the KATIE CHAIR immediately if you suspect damage or any other fault. If in any doubt, please do not issue or use, but immediately contact your supplier for service support.

SERVICING

REDGUM Brand recommend that you should have your **KATIE CHAIR** serviced every **SIX months** or less if used by, or issued to, various users. Servicing should be carried out by an approved service technician or by REDGUM Brand directly.

Do not fit any parts or accessories to your **KATIE CHAIR** that are manufactured by another company. To do so will void your warranty and may seriously compromise your safety.

CLEANING

Clean your chair using a non-abrasive cleaner or mild detergent with a soft cloth.

Abrasive cleaners e.g. AJAX and / or abrasive cleaning pads could seriously damage the chair beyond repair and should not be used.

Always ensure that you wipe dry the chair after cleaning.

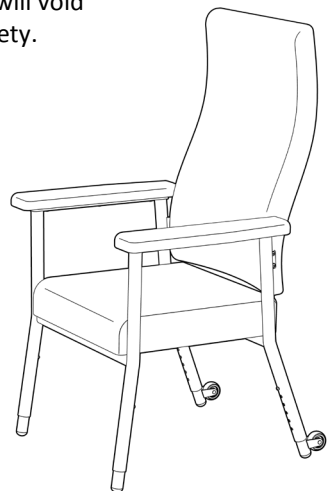

WARRANTY

Your REDGUM Brand **KATIE CHAIR** is covered by a **12 Month Warranty** from the date of purchase.

If the product has any manufacturing faults during this period contact the place of purchase for assessment. Failures as a result of **ACCIDENTAL DAMAGE, MISUSE, MODIFICATION OR WEAR AND TEAR ARE NOT COVERED BY THIS WARRANTY.**

Our goods come with guarantees that cannot be excluded under the Australian Consumer Law. You are entitled to a replacement part for a major failure and for compensation for any other reasonably foreseeable loss or damage. You are entitled to have the goods repaired or replaced if the goods fail to be of acceptable quality and failure does not amount to major failure.

If you have any issues
or questions about your
KATIE CHAIR
please contact your supplier
or REDGUM Brand direct on:

T: +61 8 9248 4180

F: +61 8 9248 9452

E: orders@for-de.com.au

A: 1 Business Way, Malaga
Western Australia 6090

Please keep this User Manual
in a safe place for future reference.

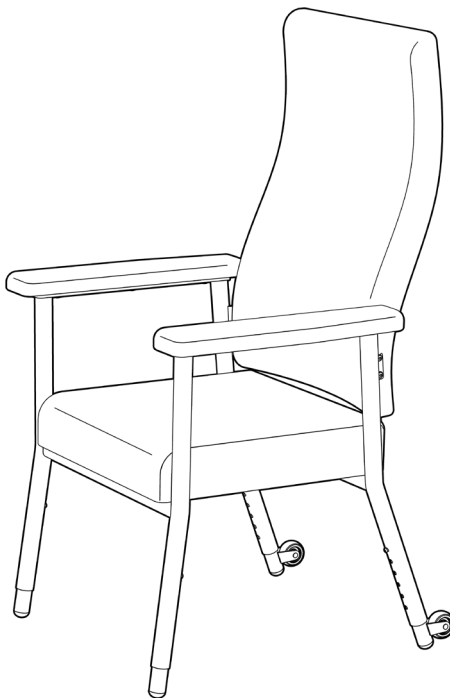

NOTES

REDGUM Brand product range

REDGUM Brand offer a comprehensive range of products including:

Seat Walkers

Side folding Walkers

Walking Frames

Wheelchairs

Walking Sticks + Quads

Crutches

Reachers

Shower / Bathroom products

Toilet products

Cushions: Air / Foam

Lift Chairs

Electric Beds

Portable Aluminium Ramps

Exercisers

Personal Alarms

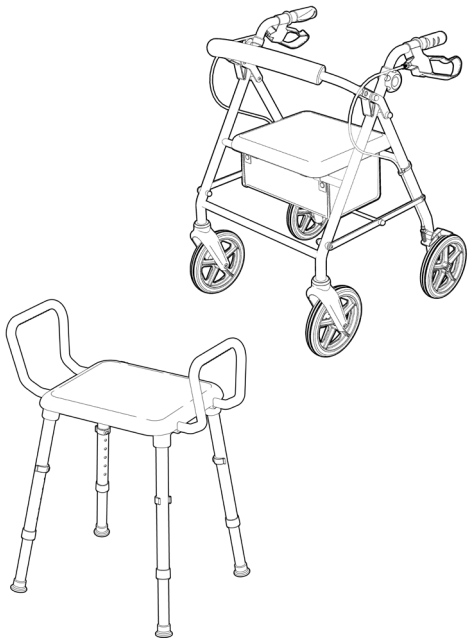

Large range of Spare Parts for all REDGUM brand products

Please contact REDGUM Brand for further information:

T: +61 8 9248 4180

F: +61 8 9248 9452

E: orders@for-de.com.au

A: 1 Business Way, Malaga Western Australia 6090

W: www.redgumbrand.com.au

DISTRIBUTOR:

REDGUM BRAND
Daily Living and
Lifestyle Products



Proudly Australian Owned and Operated